

## ML6421A,B ELECTRIC LINEAR VALVE ACTUATORS

### SPECIFICATION DATA

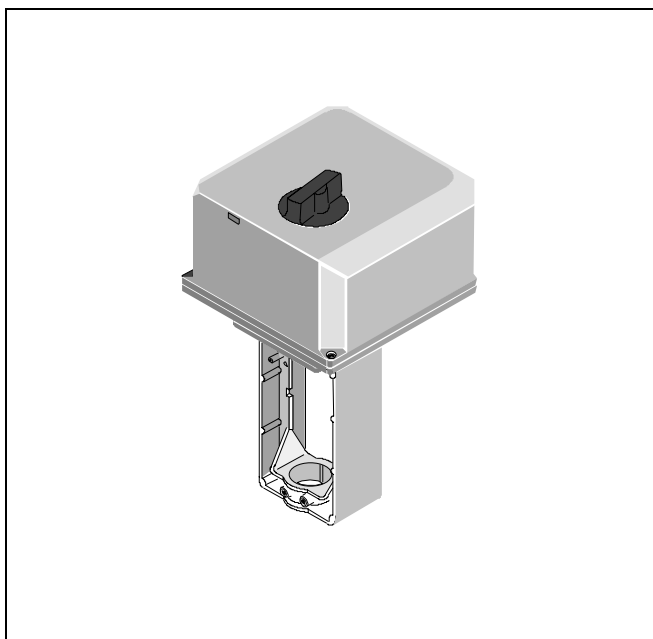

### GENERAL

These valve actuators are for floating control and equipped with a synchronous motor for exact positioning. They can be used with controls providing switched or floating single pole double through (SPDT) control outputs to operate Honeywell's standard valve series in heating, ventilation and air conditioning (HVAC) applications.

### FEATURES

- Easy and quick installation
- No separate linkage required
- No adjustments
- Force limiting end switches
- Manual operator
- Models for low and line voltage
- Synchronous motor
- Corrosion resistant design
- Maintenance free

### SPECIFICATIONS

#### Temperature Limits

Ambient operating limits	-10 to +50°C @ 5 to 95%rh
Ambient storage limits	-40 to +70°C @ 5 to 95%rh
Medium valve temperature	Max.+150°C (+220°C with High Temperature Kit)

#### Safety

Protection class	II in acc. with EN60730-1
Protection standard	IP54 in acc. with EN60529
Flame retardant housing	V0 in acc. with UL94, with metal cable gland

#### Noise level

≤45dB(A)

#### Wiring

Wiring terminals	1.5mm <sup>2</sup>
Cable entry	PG13.5 (1/2") and PG11; knock out can be enlarged to PG16

#### Material

Cover	ABS
Yoke and base	Aluminium diecast

#### Weight

2.0kg

#### Dimensions

See Fig. 1.

По вопросам продаж и поддержки обращайтесь:

Астана +7(7172)727-132, Волгоград (844)278-03-48, Воронеж (473)204-51-73, Екатеринбург (343)384-55-89,  
 Казань (843)206-01-48, Краснодар (861)203-40-90, Красноярск (391)204-63-61, Москва (495)268-04-70,  
 Нижний Новгород (831)429-08-12, Новосибирск (383)227-86-73, Ростов-на-Дону (863)308-18-15, Самара (846)206-03-16,  
 Санкт-Петербург (812)309-46-40, Саратов (845)249-38-78, Уфа (347)229-48-12  
 Единый адрес: hwn@nt-rt.ru  
 www.honeywell.nt-rt.ru

Model Number	ML6421A3005	ML6421B3004	ML6421A3013	ML6421B3012
Supply Voltage	24Vac (±15%); 50/60Hz		230Vac (+10%/-15%); 50/60Hz	
Power Consumption	9VA (50Hz) / 11VA (60Hz)		11VA (50Hz) / 13VA (60Hz)	
Signal Input 1	Supply voltage between terminals 1 and 24 V~; actuator stem extended: two way valve closed; three way valve port A - AB open.		Supply voltage between terminals N and Ph 1; actuator stem extended: two way valve closed; three way valve port A - AB open.	
Signal Input 2	Supply voltage between terminals 2 and 24 V~; actuator stem retracted: two way valve open; three way valve port A - AB closed.		Supply voltage between terminals N and Ph 2; actuator stem retracted: two way valve open; three way valve port A - AB closed.	
Stroke	20mm	38mm	20mm	38mm
Run Time @ 50Hz	1.9min	3.5min	1.9min	3.5min
Nominal Stem Force	1800N			

## OPERATION

### General

The drive of the synchronous motor is converted into linear motion of the actuator stem by using a worm gear transmission. The actuator stem is connected with the valve stem by a button keyed retainer connection.

The internal force sensor switches off the actuator precisely via installed microswitches when the nominal stem force is reached.

### Manual Operation

The actuators are equipped with a manual operator used in case of power failure. Manual operation is only allowable after the power supply is switched off or disconnected.

To operate push the manual operator knob down and turn counter-clockwise to move the stem downwards and clockwise to move the stem upwards. If the actuator returns to automatic control, the manual operator knob unlocks automatically.

**NOTE:** Manual operation allows a very high closing force which can cause the actuator spindle to jam, exceeding the rating of the force switches, so that the motor can not move. Therefore, after a manually close-off operation, it is necessary to release the spindle one turn by turning the manual operator knob, so that the manual operator will automatically disengage on power resumption.

### Accessories

Following accessories are available upon request:

#### - Auxiliary switches

The actuators can be equipped on site with an auxiliary switch unit with two switches. Their switching points are adjustable over the full length of the actuator stroke. The switches can be used to switch pumps or to provide remote indication of any stroke position.

A cable gland PG11 is delivered with the unit.

#### - Auxiliary potentiometer

The auxiliary potentiometers are available for mounting on site. They can be used as feedback potentiometer and/or to provide remote indication of the valve position.

A cable gland PG11 is delivered with the unit.















Accessory-Type	for Stroke	Order No.
Auxiliary switches 250Vac/10A (package contains 2 SPDT switches)	20mm 38mm	43191680-002
Single auxiliary potentiometer (full range 220Ω; operating range 135Ω)	20mm	43191679-001
	38mm	43191679-002
Single auxiliary potentiometer (10kΩ)	20mm	43191679-007
	38mm	43191679-008

**- High Temperature Kit**

Two options for applications +150°C...+220°C medium valve temperature are available for following valves:

Valve	DN	High Temperature Kit Order No.
V5011A/V5011K V5013A/V5013G V5011R/V5013R V5328A/V5329A	15 - 40 15 - 40 15 - 50 15 - 32	43196000-001
V5011A V5013A/V5013G V5328A/V5329A V5049A V5050A	50 50 40 - 80 15 - 65 15 - 80	43196000-002

**CLOSE-OFF PRESSURE RATINGS**

Stroke		20mm								38mm			
Valve	mm	15	20	25	32	40	50	65	80	80	100	125	150
Size	inch	1/2	3/4	1	1 ¼	1 ½	2	2 ½	3	3	4	5	6
Valves		Close-Off Pressure Ratings (in kPa)											
V5011R				1600	1600	1500	850	-	-	-	-	-	-
V5011K				1600	1600	-	-	-	-	-	-	-	-
V5013R				1600	1600	1500	850	-	-	-	-	-	-
V5015A		-	-	-	-	-	-	-	-	-	150	120	80
V5328A		1600	1600	1600	1600	1300	750	470	230	-	-	-	-
V5329A (PN16)						1000	1000	1000	650	400	-	-	-
V5329C (PN6)						600	600	600	400	-	-	-	-
V5049A		2500	2500	2500	2000	1300	750	500	-	230	230	90	90
V5050A		2500	2500	2500	2000	1300	750	500	230	-	230	90	90

 = Use 600N actuator

For specific data of the listed valves see following Specification Data No.:

V5011K EN0C-0560  
V5011R EN0B-064  
V5013R EN0B-065  
V5015A EN0C-0431  
V5049A EN0C-0433  
V5050A EN0C-0435  
V5328A EN0C-0432  
V5329A,C EN0C-0434

## DIMENSIONS

ML6421A

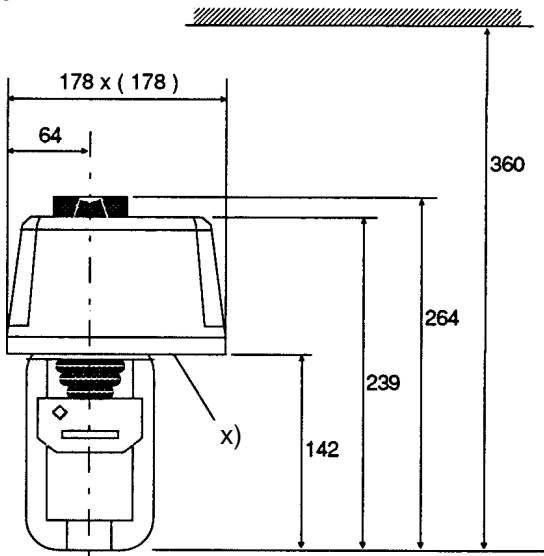

ML6421B

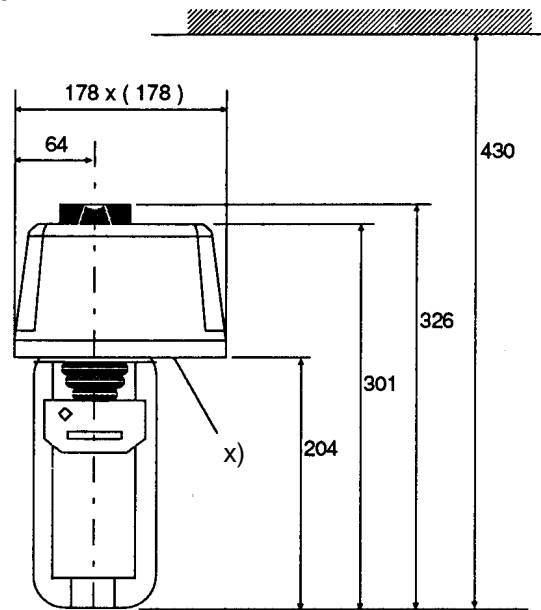

x) Two knock outs are provided for cable fitting:  
Ø 21.2 (PG13.5) / Ø 22.8 (PG16),  
Ø 18.9 (PG11) / Ø 22.8 (PG16)

Fig. 1. Dimensions in mm

## WIRING

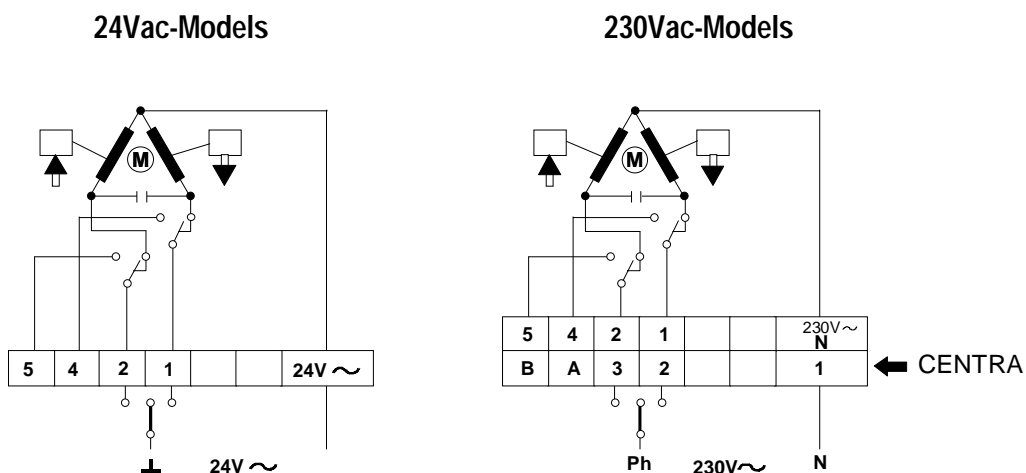

## ACCESSORIES

Auxiliary Potentiometer

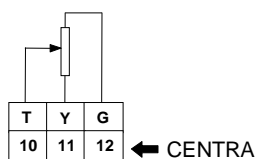

Auxiliary Switches

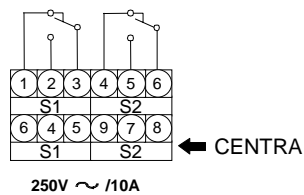

Fig. 2. Wiring

По вопросам продаж и поддержки обращайтесь:  
 Астана +7(7172)727-132, Волгоград (844)278-03-48, Воронеж (473)204-51-73, Екатеринбург (343)384-55-89,  
 Казань (843)206-01-48, Краснодар (861)203-40-90, Красноярск (391)204-63-61, Москва (495)268-04-70,  
 Нижний Новгород (831)429-08-12, Новосибирск (383)227-86-73, Ростов-на-Дону (863)308-18-15, Самара (846)206-03-16,  
 Санкт-Петербург (812)309-46-40, Саратов (845)249-38-78, Уфа (347)229-48-12  
 Единый адрес: hwn@nt-rt.ru  
 www.honeywell.nt-rt.ru